

PROTON CYCLOTRON FOR BEAM THERAPY APPLICATION

*Yu.G. Alenitsky, A.A. Glazov, G.A. Karamysheva, S.A. Kostromin, L.M. Onischenko,
E.V. Samsonov, S.B. Vorozhtsov, A.S. Vorozhtsov, N.L. Zaplatin
Dzhelepov Laboratory of Nuclear Problems, Joint Institute for Nuclear Research
141980, str. Joliot-Curie, 6, Dubna, Russia
fax:+7-49621-66666*

Project of the proton cyclotron for a beam therapy application is now under development in Dzhelepov LNP JINR. Main parameters of this machine are already reported and discussed in the proceedings of the RUPAC04 [1] and RUPAC06 [2] and in "Applied Physics" magazine [3]. Dynamic characteristics of the beam at the range of radii more than 100 cm are specified. Different variants of the protons energy increase are also discussed.

PACS 29.20.Hm

INTRODUCTION

In practice of treatment on the medical beam LNP JINR the beam with energy 170 MeV and current $I_p \sim 0.1$ mA most frequently are used. A six-cabin medical facility has been developed in LNP JINR and put into operation on the base of Phazotron beam. Original methods and technologies for forming dose fields have been developed and successfully applied in a clinic as well as new methods of reconstructive proton tomography for treatment of patients with the medical Phasotron beams.

All attempts to reduce the beam energy extracted from Phasotron need the significant financial expenses for change its magnetic and accelerating systems. We suppose, that it is more rational to create a new cyclotron with the required parameters of beams and to assembly it in the LNP JINR to use it in the medical complex. Under the offered project it is also possible to create cyclotron for other interested organizations.

THE BASIC PARAMETERS OF CYCLOTRON

MAGNETIC SYSTEM

Isochronous cyclotron for proton therapy is proposed to be created on the basis of a compact four sectors magnet with a circle return yoke having an outside diameter 5.2 m and height 2.4 m. Some types of the return yokes were calculated to compare them.

General view of mathematical model of the bottom part of such types of magnets is shown in the Figs.1,a,b,c. The required configuration of a magnetic field is formed by means of spiral and angular extent of the sector shims depending on radius.

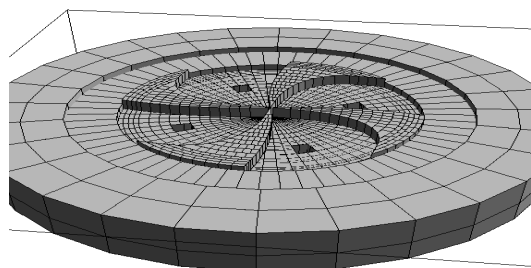

Fig.1,a. 3D view of the proton cyclotron C200p magnetic system (circle return yoke)

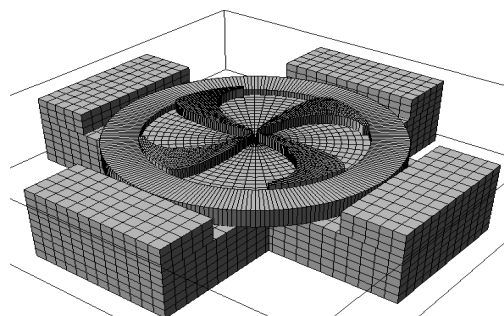

Fig.1,b. 3D view of the proton cyclotron C200p magnetic system (four symmetry return yoke)

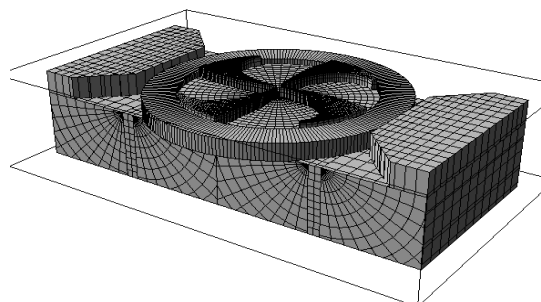

Fig.1,c. 3D view of the proton cyclotron C200p magnetic system (two symmetry return yoke)

Modeling of the cyclotron magnetic system was carried out by means of the code *Radia ver. 4.098* [4], which works under *Mathematica* platform and calculates magnetic field of the three-dimensional magnetic systems by a method of the integrated equations. As a material of the magnet the steel – 10 was used.

The complete angular extent of one sector on a pole is 55° , thus in valleys there is an opportunity to place 42° rectilinear resonators.

Consideration of the magnets (see the Figs.1a,b,c) has shown that the difference caused by the return yoke form does not exceed 150 G of an average magnetic field. Formation of the field in such range can be made by means of the special steel shims.

For the consumer the important characteristics of installation are both the sizes and a technology of manufacturing of the project, and both operational conditions – consumed energy and cost of service. We propose on the base of our results, that the offered project C200p with four symmetry return yoke (see Fig.1,b) is optimum and that such installation can be created as a pilot project of our institute.

BEAM DYNAMICS

In the Figs.2-4 the dynamic characteristics of a beam in the magnetic field calculated for magnet with circle yoke (Fig.1,a) are shown. The frequencies of axial and radial motion (see Fig.2) are in allowable limits.

Working point diagram along the acceleration in C200p is presented in Fig.3. The point to point distance is 10 MeV. The most dangerous resonance $Q_r - Q_z = 1$ is crossed two times at energies 130 and 190 MeV. Modeling of the particle dynamics showed that no axial amplitude increase observed after the resonance (see below) if no skew harmonics presented in magnetic field map. Further computations have to define permissible limits of such harmonics.

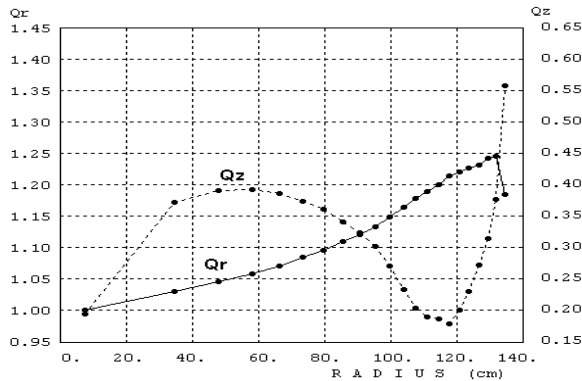

Fig.2. Betatron frequencies along radius

Proton resonance orbital frequency is 20.4545 MHz. Particle axial motion along acceleration in the magnetic field is shown in Fig 4 with no skew harmonics. Amplitude of particle radial oscillation was 5 mm in these computations. Change of the axial oscillations amplitude corresponds to the dependence of axial betatron frequency on the radius.

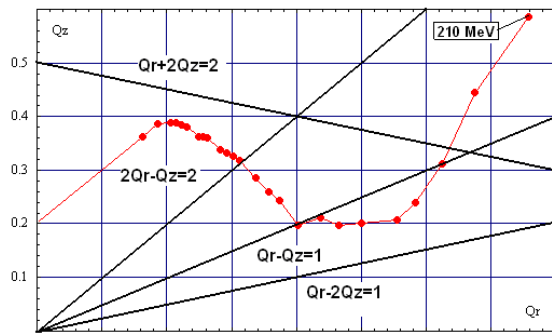

Fig.3. Working point diagram

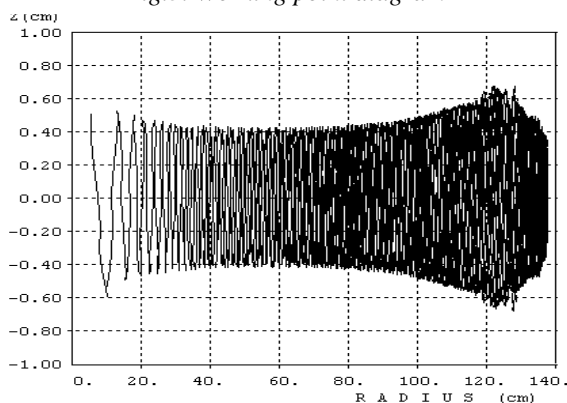

Fig.4. Particle axial motion

Maximal energy of the protons in this cyclotron is limited by $E \approx 200$ MeV due to a resonance $Q_z = 0.5$, which arises at radius 1.35 m, (see Fig.3), where the average magnetic field begins to fall. It is connected with the pole edge located near this region. To provide a growing, isochronous field, the gap between sectors is possible to reduce (example – C230 IBA), but this could lead to the technical difficulties, or to increase a diameter of the magnet pole.

For the medical centre LNP JINR the estimated energy of protons is sufficient. An increase of the protons energy is possible at additional increase of the expenses for creation of the installation.

RADIOFREQUENCY SYSTEM

Rectilinear on radius the accelerating resonators which have angular extent 42° and 30° dee are used. They are located in valleys, where the gap between poles is 400 mm. The adjustment and excitation of resonators is carried out through the coaxial lines. The central rod located from above and from below is used for the dee support. Parts of the lines, which leave for the size of 400 mm are placed in the channels of poles of the magnet. The basic parameters of high-frequency system were obtained making use a three-dimensional code. For excitation of the accelerating system it is proposed to use the standard high-frequency generator on the suitable capacity and frequency 81.8 MHz working on linkage feeder (see Fig.5).

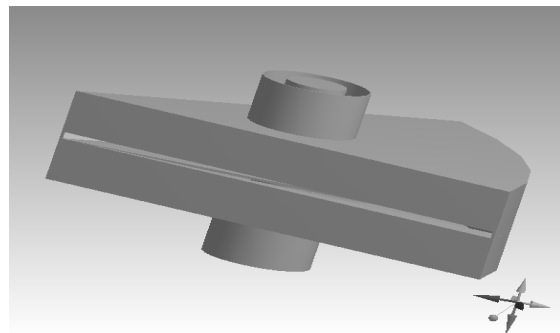

Fig.5. General view of the calculating model for accelerating system

EXTRACTION SYSTEM

The extraction system consists of the beam radial enhancement system, electrostatic sections, bending and focusing magnetic elements. At the moment only central ion extraction has been calculated. To study the beam acceleration at final radii and the efficiency of the extraction it is necessary to fulfill some additional calculations.

OTHER CYCLOTRON SYSTEMS

The design of the cyclotron vacuum chamber depends on the form of the return yoke. In our opinion the magnet with four return yokes is more convenient to make technological service of the cyclotron.

Diagnostics of the parameters of accelerated beam is carried out by three probes, one of them is on the en-

trance of extraction channel. On the exit of electrostatic section of the channel the fourth short probe is arranged.

In connection with a rather low required intensity of the beam in this cyclotron, it is possible to use a Penning ion source, which is moved from above in the centre of cyclotron. Acceleration and the formation of the beam during the first turns is carried out with the help of special central optics.

CONCLUSIONS

The physical consideration of proton cyclotron on the energy of about $E_p \sim 200$ MeV was given. This cyclotron will provide all scientific and medical programs on the medical beam of Dzheleпов Laboratory of Nuclear Problem, Joint Institute for Nuclear Research.

REFERENCES

1. Yu.G. Alenitsky, et al. Cyclotron for beam therapy application // *XIX Russian Particles Accelerator Conf. Proc.* p.162-164, Dubna 2005.
2. Yu.G. Alenitsky, et al. Cyclotron for therapy application (in Russian) // *XX Russian Particles Accelerator Conf. Proc.* Novosibirsk, 2007, p.162-164.
3. Yu.G. Alenitsky, et al. Cyclotron for therapy application (in Russian) // *Applied Physics.* 2005, №5, p.50-54.
4. P. Elleaume, O. Chubar, J. Chavanne. Computing 3D Magnetic Field from Insertion Devices // *Proc. of the PAC97 Conference.* May 1997, p.3509-3511.

Статья поступила в редакцию 16.08.2007 г.

ПРОТОННЫЙ ЦИКЛОТРОН ДЛЯ ЛУЧЕВОЙ ТЕРАПИИ

Ю.Г. Аленицкий, А.А. Глазов, Г.А. Карамышева, С.А. Костромин, Л.М. Онищенко, Е.В. Самсонов, С.Б. Ворожцов, А.С. Ворожцов, Н.Л. Заплатин

В ЛЯП ОИЯИ разрабатывается протонный циклотрон для лучевой терапии, основные параметры систем ускорителя изложены в работах, представленных на конференциях RUPAC04, RUPAC06 и в журнале «Прикладная физика». В работе уточняются динамические характеристики пучка в диапазоне радиусов $R > 100$ см и рассматриваются возможности увеличения энергии протонов.

ПРОТОННИЙ ЦИКЛОТРОН ДЛЯ ПРОМЕНЕВОЇ ТЕРАПІЇ

Ю.Г. Аленицький, А.А. Глазов, Г.А. Карамішева, С.А. Костромін, Л.М. Онищенко, Е.В. Самсонов, С.Б. Ворожцов, А.С. Ворожцов, Н.Л. Заплатін

У ЛЯП ОІЯД розробляється протонний циклотрон для променевої терапії, основні параметри систем прискорювача викладені в роботах, представлених на конференціях RUPAC04, RUPAC06 і у журналі "Прикладна фізика". У роботі уточнюються динамічні характеристики пучку в діапазоні радіусів $R > 100$ см і розглядаються можливості збільшення енергії протонів.